

WIRED



Non-compliance with the specification might cause risk for life or health and can determine proper work of the roller shutter.

We strongly recommend to comply with the specification.

Installation of the tubular motor should be performed by specialists with 1kV or higher SEP-certified electrician's licence (SEP - Association of Polish Electrical Engineers) or equal license.

General information



BD type motors are designed for automation of roller shutters or garage doors. It's equipped with function of obstacle detection that forces motor to stop rotating whenever there's an obstacle. Obstacle detection works both ways and is functional when motor is attached to tube with security locks, as well as retainer springs.

Electronic limit position switches, set by programming button on motors head, with a setting cable or automatically, allow for motor to be programmed easily and precisely.

Motors can be connected by series and parallel circuits, what allows for many motors to be controlled with a single switch, without having to create additional electrical networks.

Max time of continuous work:
4 min.

Power supply:
230 V / 50 Hz

Operating temperature:
from -25°C to 50°C

Protection degree:
IP 44

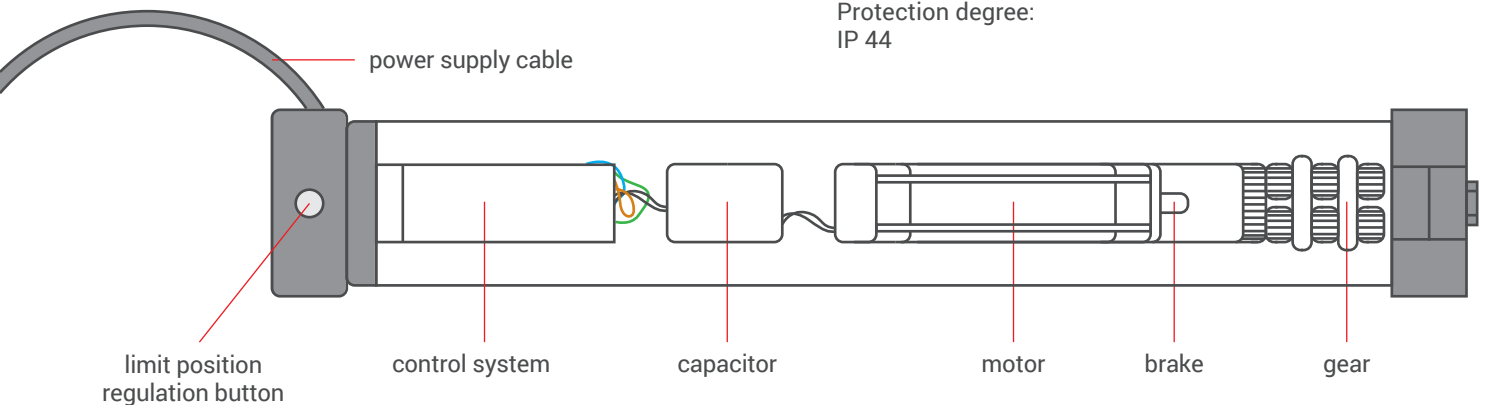

Maximal time of continuous work is 4 minutes. After that time thermal protection will be activated preventing motor from overheating. After that motor will be disabled for about 20 minutes until it cools down.

Safety measures

Before installing or using motor please read the following instruction. Installation of the tubular motor should be performed by specialists with 1kV or higher SEP-certified electrician's licence (SEP - Association of Polish Electrical Engineers) or equal license. Montage should be done by a qualified installer with compliance with all requirements and norms implemented in the country of installation as well as should transfer all information concerning usage and maintenance of the device to the user. Non-compliance to this instruction of installation and usage can present risks to health and safety of installer and/or user and may cause failures in correct operation of the roller shutter. Negligence of mentioned safety measures may lead to the lapse of liability for damages in the event of damage or loss.



Motors torque parameter should be adequate to the weight of the roller shutter curtain.



Wiring should be mounted in a way preventing water from entering the tubular motor, as well as for moving roller shutter curtain to make any damage.



Electrical system control should be performed regularly to detect any signs of use or damage of the motor.



Electrical supply needs to be disconnected before conducting any maintenance, cleaning and/or repair work.



All contact of the motor with any liquids should be reduced to minimum.



No tools should be used when placing motor in the tube.



During the adapter montage special attention must be paid not to damage the motor.

WIRED



Non-compliance with the specification might cause risk for life or health and can determine proper work of the roller shutter.

We strongly recommend to comply with the specification.

Installation of the tubular motor should be performed by specialists with 1kV or higher SEP-certified electrician's licence (SEP - Association of Polish Electrical Engineers) or equal license.

Safety measures



Motor and its control system should be kept out of reach of children.



Controller should be placed not lower than 140 cm from the floor level and in distance allowing to observe the movement of the roller shutter.

Placing motor in the tube



Motor should be mounted in places protected from unfavourable weather conditions.

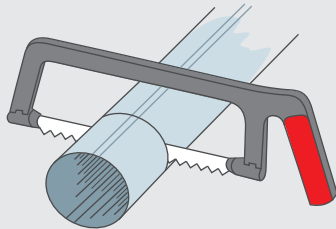

1. Cut the tube to the proper length.

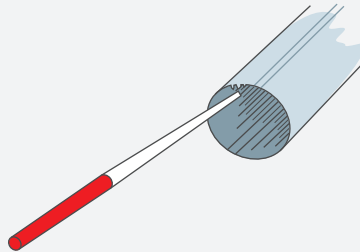

2. Deburr the edges and remove the metal residue.

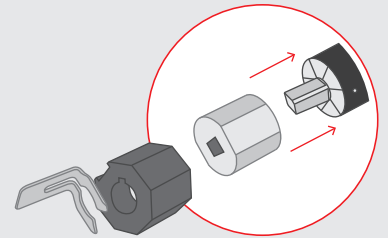

3. Place the adaptation on the motor.

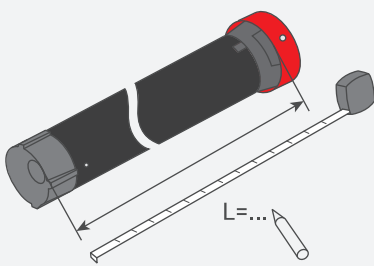

4. Measure the distance (L) between the inner edge of motors head and the end of the motors adaptor.

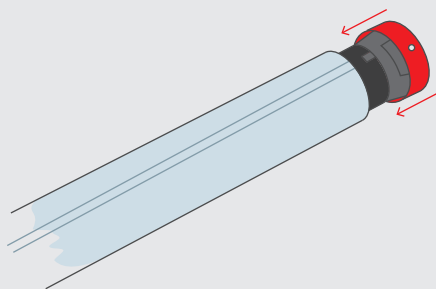

5. Insert the motor into the tube up to the point of connection between the edge of the tube and the inner edge of the motors head.

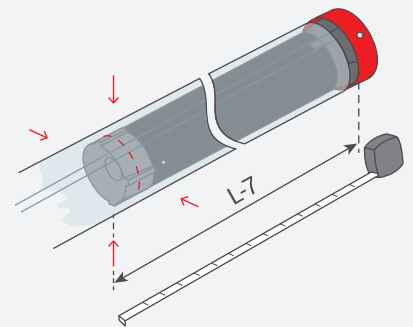

6. Secure the tube to the coupling part of the adaptation using 4 screws or rivets, placed at L-7 mm distance from the inner edge of the motors head.

WIRED



Non-compliance with the specification might cause risk for life or health and can determine proper work of the roller shutter.

We strongly recommend to comply with the specification.

Installation of the tubular motor should be performed by specialists with 1kV or higher SEP-certified electrician's licence (SEP - Association of Polish Electrical Engineers) or equal license.

Connection



1. Voltage should measure $230V \pm 5\%$. If the voltage is out of this range it can cause sudden stop of the motor. If that occurs load of the motor should be halved.
2. Used switch should be intended for roller shutters control.
3. After setting limit positions white wire, used for limit position setting, should be connected to neutral wire of energy source.

1. Connection scheme of blind switch before setting limit positions

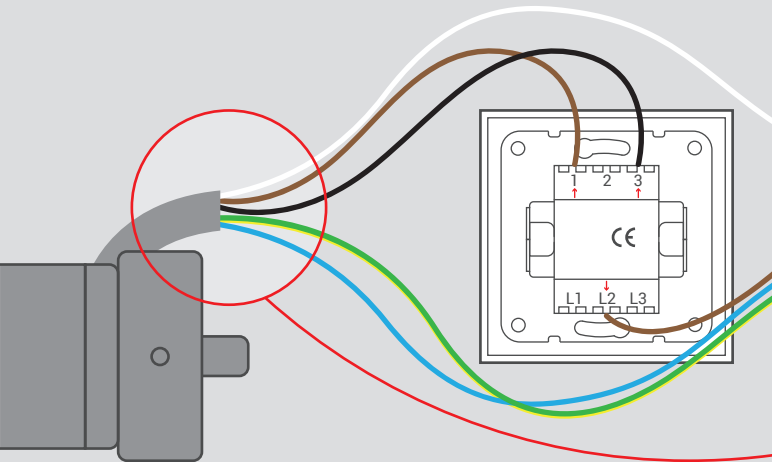

WIRE	FUNCTION
white	setting limit positions
brown	direction 1
black	direction 2
yellow-green	protection
blue	neutral

2. Connection scheme of blind switch after setting limit positions

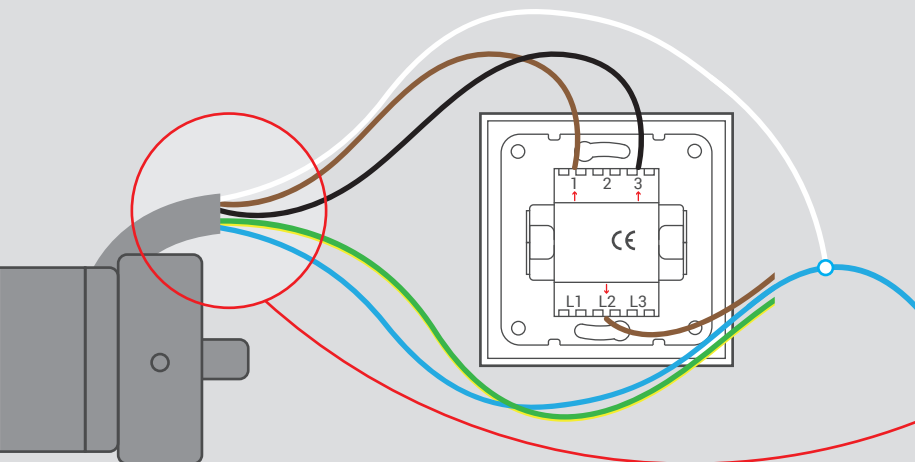

WIRE	FUNCTION
white	programowanie położeń krańcowych
brown	direction 1
black	direction 2
yellow-green	protection
blue	neutral

WIRED



Non-compliance with the specification might cause risk for life or health and can determine proper work of the roller shutter.

We strongly recommend to comply with the specification.

Installation of the tubular motor should be performed by specialists with 1kV or higher SEP-certified electrician's licence (SEP - Association of Polish Electrical Engineers) or equal license.

Connection



White wire is used only when limit positions are being set using setting cable.

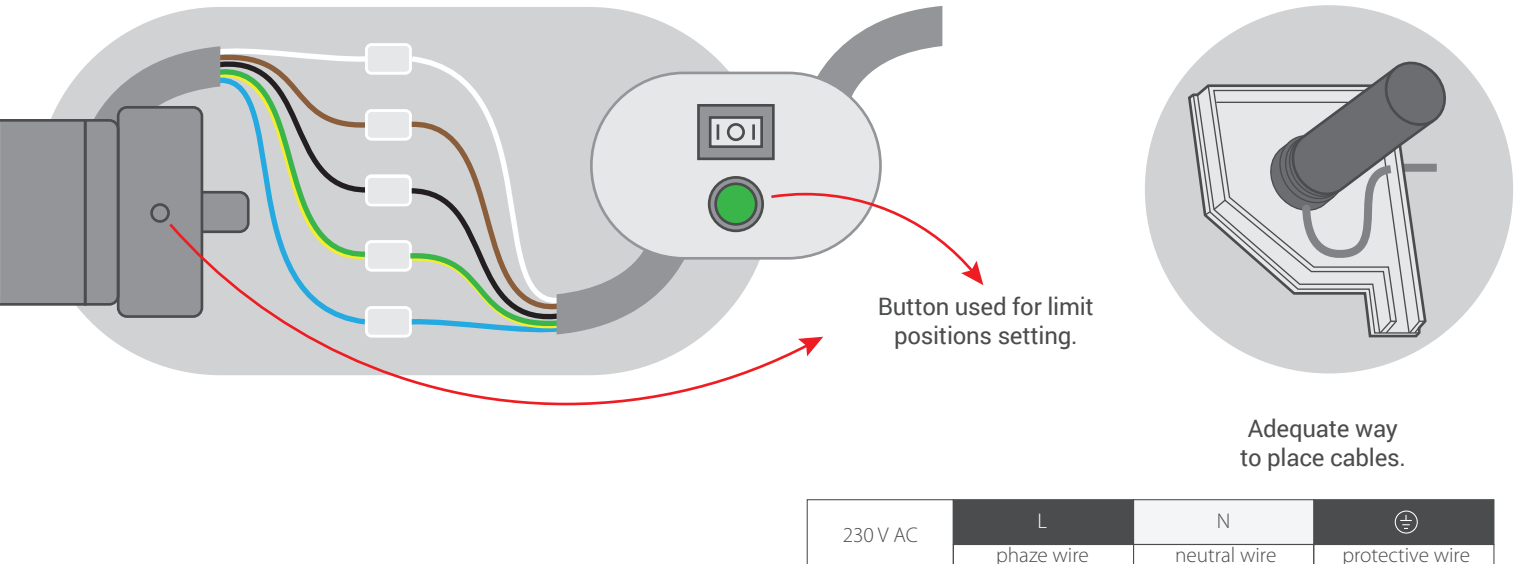

Maximal number of motors connected in parallel way is determined by short circuit capacity of the switch and long-term capacity of power supply cable.

Setting limit positions



1. Limit positions can be set in one of three ways:

- a) automatically,
- b) using setup cable for motors,
- c) using button placed on motors head.

2. If the distance between limit position is too long, limit positions should be reduced by pressing programming button placed on motors head or on the setup cable while motor is working (whilst raising or lowering the roller shutter).

WIRED



Non-compliance with the specification might cause risk for life or health and can determine proper work of the roller shutter.

We strongly recommend to comply with the specification.

Installation of the tubular motor should be performed by specialists with 1kV or higher SEP-certified electrician's licence (SEP - Association of Polish Electrical Engineers) or equal license.

Setting limit positions Automatically



For automatic setup it's necessary to use some form of roller shutter stopping mechanism at the bottom slat (e.g. profile runner stopper). It needs to be noticed that upper limit position is always being set as the first one. Before activating automatic function it has to be determined that no other limit positions are already programmed in motors memory. If there are any they should be deleted (see point 'Deleting limit positions').

To automatically set limit positions these steps need to be taken:

1. Run motor in up positions.
2. When roller shutter reaches upper limit position motor will register resistance and stop, and then move roller shutter in the opposite direction.
3. When roller shutter will reach lower limit position motor will register resistance and stop, and then move roller shutter in the opposite direction for an control cycle of already detected limit positions.

After successfully determining limit positions motor will open the roller shutter by moving it to the upper limit position. After these steps it's necessary to run motor in both directions to ensure, that both new limit positions were saved in motors memory.

Setting limit positions Using setup cable

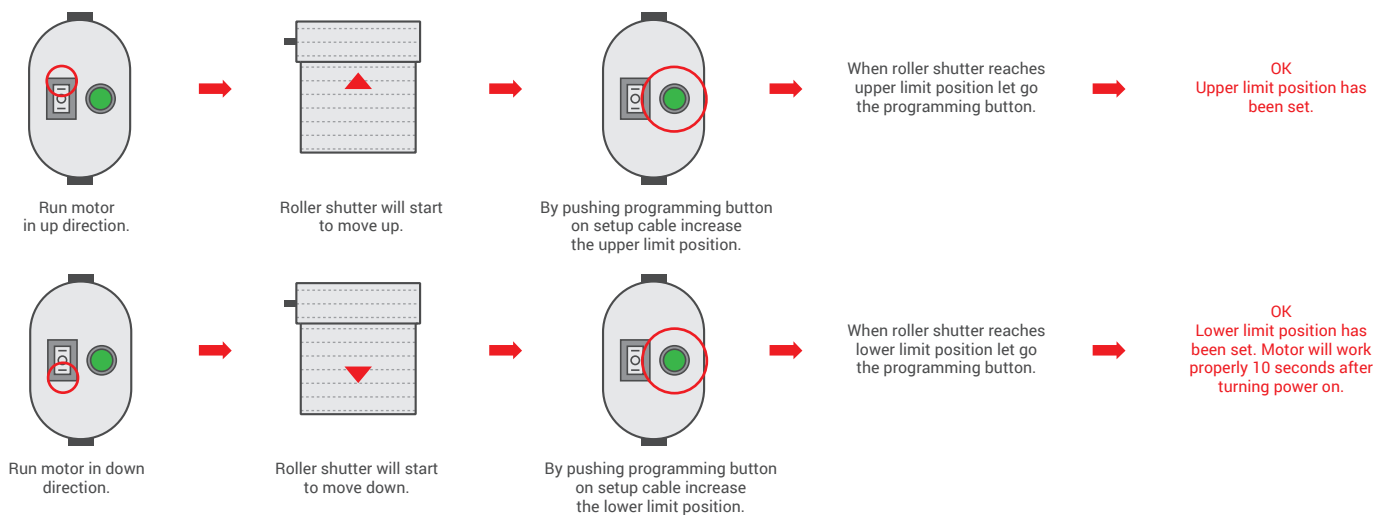

Setting limit positions Using programming button on motors head

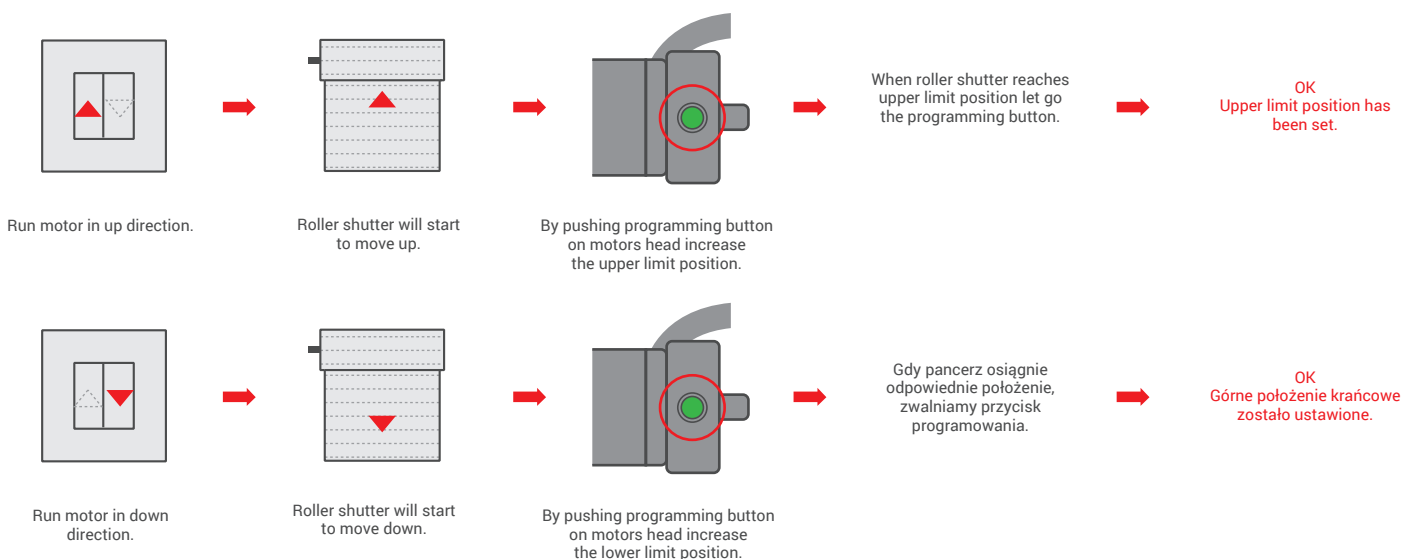



Non-compliance with the specification might cause risk for life or health and can determine proper work of the roller shutter. We strongly recommend to comply with the specification. Installation of the tubular motor should be performed by specialists with 1kV or higher SEP-certified electrician's licence (SEP - Association of Polish Electrical Engineers) or equal license.

Deleting limit positions

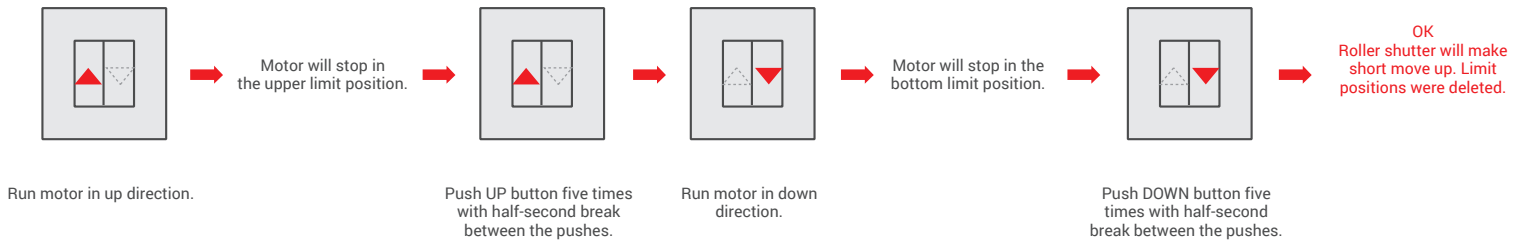

Choosing motors reaction on resistance

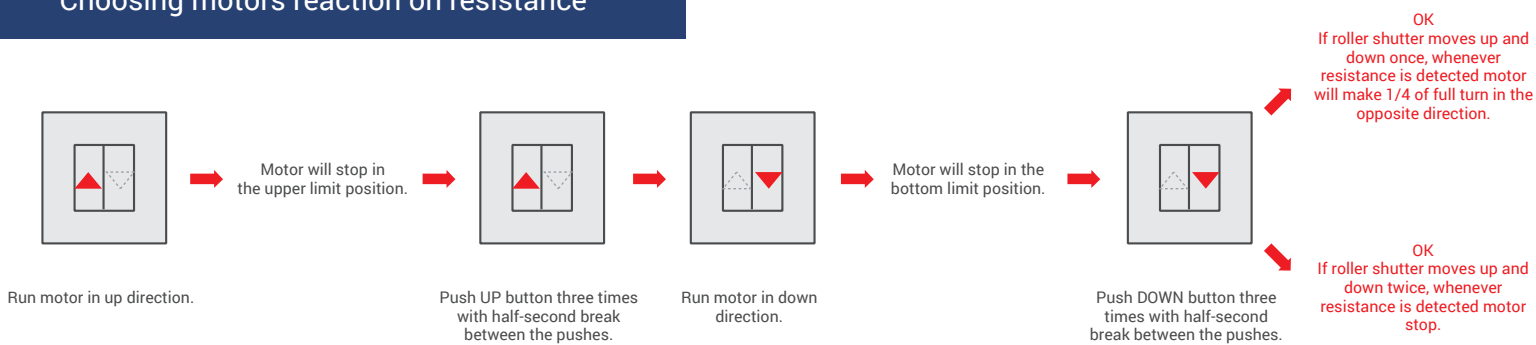

Hoosing work mode of the obstacle detection function

