

433 MHz



Non-compliance with the specification might cause risk for life or health and can determine proper work of the roller shutter. We strongly recommend to comply with the specification. Installation of the tubular motor should be performed by specialists with 1kV or higher SEP-certified electrician's licence (SEP - Association of Polish Electrical Engineers) or equal license.

General information



R type motors with built-in radio receiver are wireless and can be controlled with a remote. Motor is designed to automate roller shutters or roller gates. Motors are equipped with microswitch, that makes transmitter programming much easier. Mechanically set limit positions allow roller shutter to stop on desired level. Motors are compatible with all YOODA brand remotes.

Radio receiver memory:
up to 20 transmitters.

Max time of continuous work:
4 min.

Power supply:
230 V / 50 Hz

Operating temperature:
from -25°C to 50°C

Stopień ochrony:
IP 44

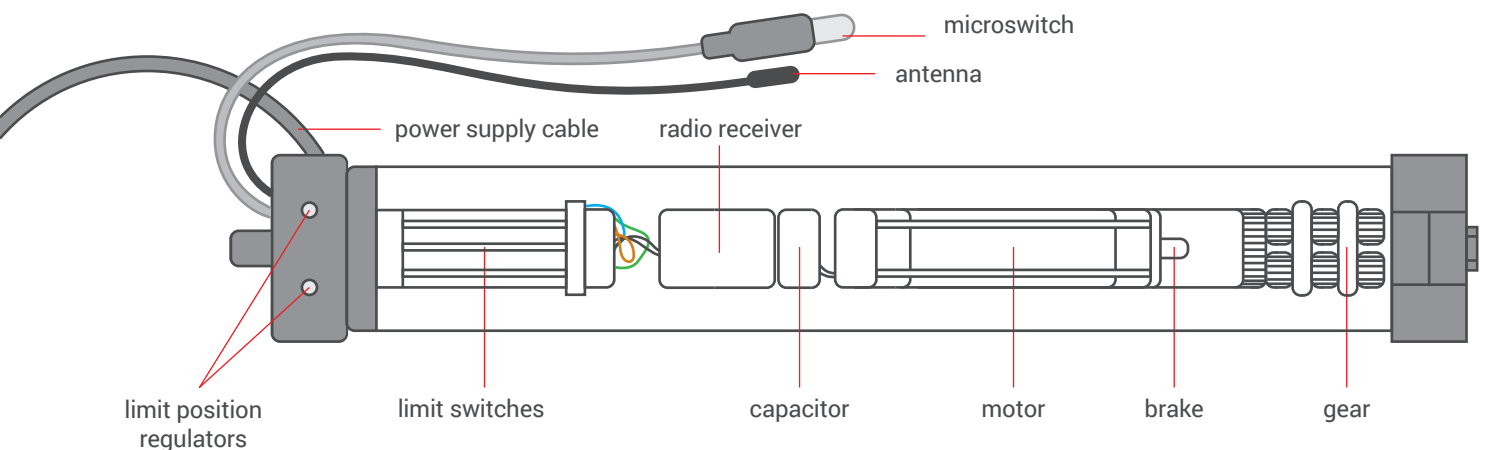

Maximal time of continuous work is 4 minutes. After that time thermal protection will be activated preventing motor from overheating. After that motor will be disabled for about 20 minutes until it cools down.

Safety measures

Before installing or using motor please read the following instruction. Installation of the tubular motor should be performed by specialists with 1kV or higher SEP-certified electrician's licence (SEP - Association of Polish Electrical Engineers) or equal license. Montage should be done by a qualified installer with compliance with all requirements and norms implemented in the country of installation as well as should transfer all information concerning usage and maintenance of the device to the user. Non-compliance to this instruction of installation and usage can present risks to health and safety of installer and/or user and may cause failures in correct operation of the roller shutter. Negligence of mentioned safety measures may lead to the lapse of liability for damages in the event of damage or loss.



Motors torque parameter should be adequate to the weight of the roller shutter curtain.



Electrical system control should be performed regularly to detect any signs of use or damage of the motor.



Wiring should be mounted in a way preventing water from entering the tubular motor.



Electrical supply needs to be disconnected before conducting any maintenance, cleaning and/or repair work.

433 MHz



Non-compliance with the specification might cause risk for life or health and can determine proper work of the roller shutter. We strongly recommend to comply with the specification. Installation of the tubular motor should be performed by specialists with 1kV or higher SEP-certified electrician's licence (SEP - Association of Polish Electrical Engineers) or equal license.

Safety measures



All contact of the motor with any liquids should be reduced to minimum.



During the adapter montage special attention must be paid not to damage the motor.



No tools should be used when placing motor in the tube.



Motor and its control system should be kept out or reach of children.

Placing motor in the tube



Motor should be mounted in places protected from unfavourable weather conditions.

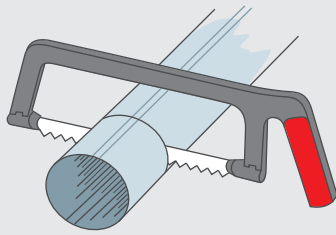

1. Cut the tube to the proper length.

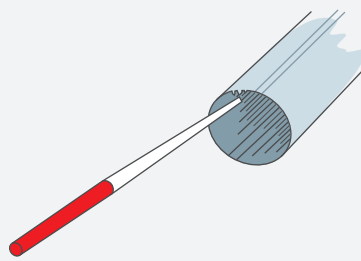

2. Deburr the edges and remove the metal residue.

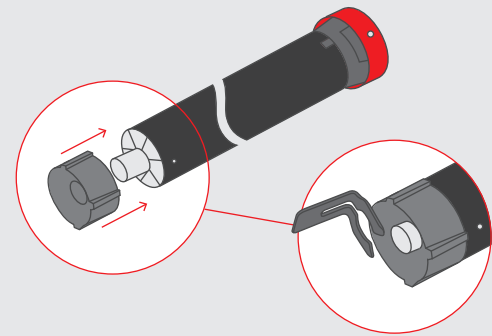

3. Place the adaptation on the motor.

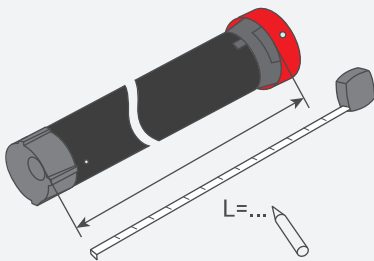

4. Measure the distance (L) between the inner edge of motors head and the end of the motors adaptor.

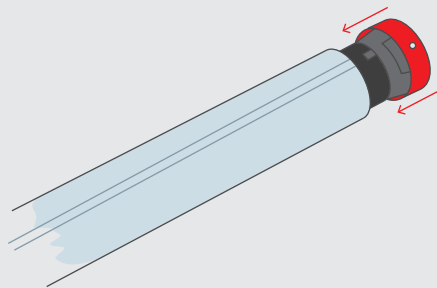

5. Insert the motor into the tube up to the point of connection between the edge of the tube and the inner edge of the motors head.

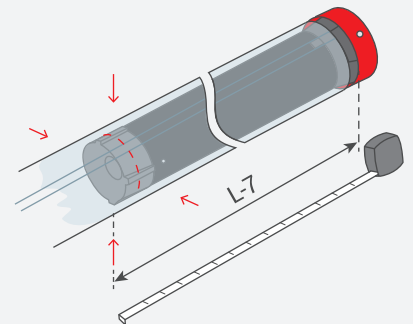

6. Secure the tube to the coupling part of the adaptation using 4 screws or rivets, placed at L-7 mm distance from the inner edge of the motors head.

433 MHz



Non-compliance with the specification might cause risk for life or health and can determine proper work of the roller shutter. We strongly recommend to comply with the specification. Installation of the tubular motor should be performed by specialists with 1kV or higher SEP-certified electrician's licence (SEP - Association of Polish Electrical Engineers) or equal license.

Connection

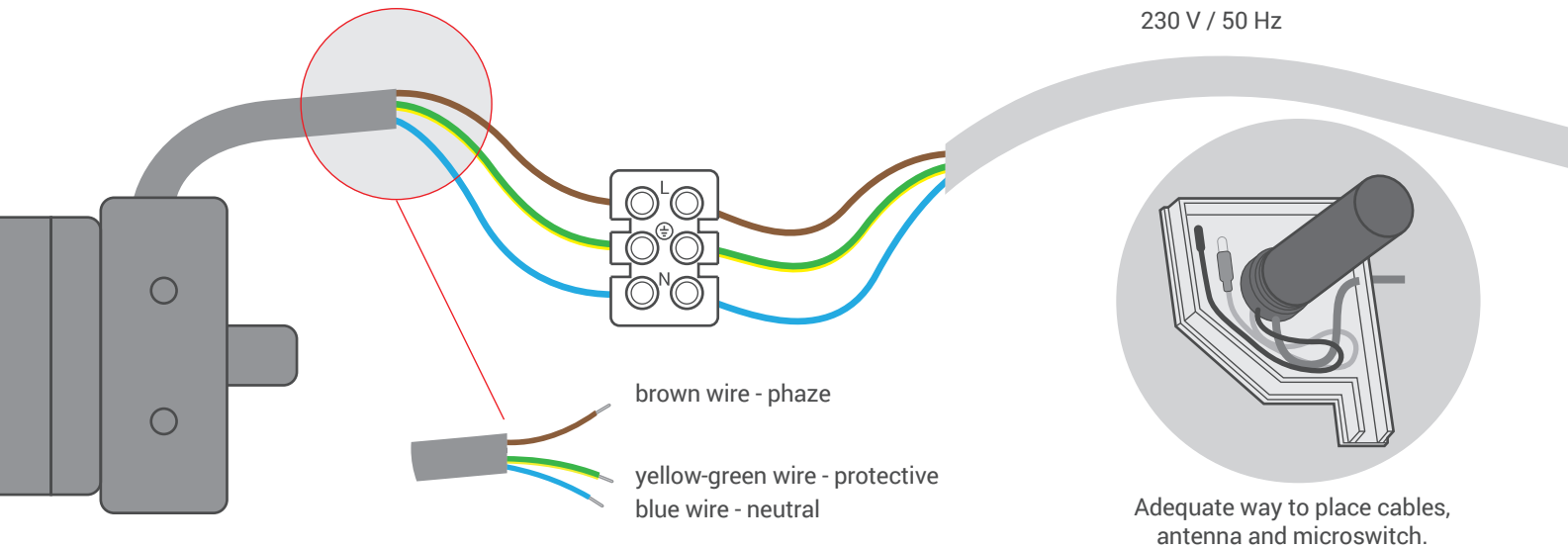

230 V AC	L	N	⊕
	phase wire	neutral wire	protective wire



Installation of the tubular motor should be performed by specialists with 1kV or higher SEP-certified electrician's licence (SEP - Association of Polish Electrical Engineers) or equal license. Device is designed to operate in places shielded from unfavourable weather conditions. Motor should be installed in accordance with all provisions of regional law and professional standards. All cables connecting power receiver with electric source should be protected from overload and short-circuits effects with devices automatically disconnecting power. Device should be powered with a separate source and protected only with a fast-blow fuse (never slow-blow fuse). Creating electrical system using inadequate fuse may result in losing rights under the provisions of warranty. When connecting device to power source with cables with adequate cross-section should be used. Long-lasting output load capacity table should be the ground for choosing adequate cables.

Range



Radio receiver range is a variable value and can differ from declared values depending on conditions in which device operates. Possible sources of changes in range are building construction, interference caused by other radio transmitters etc.

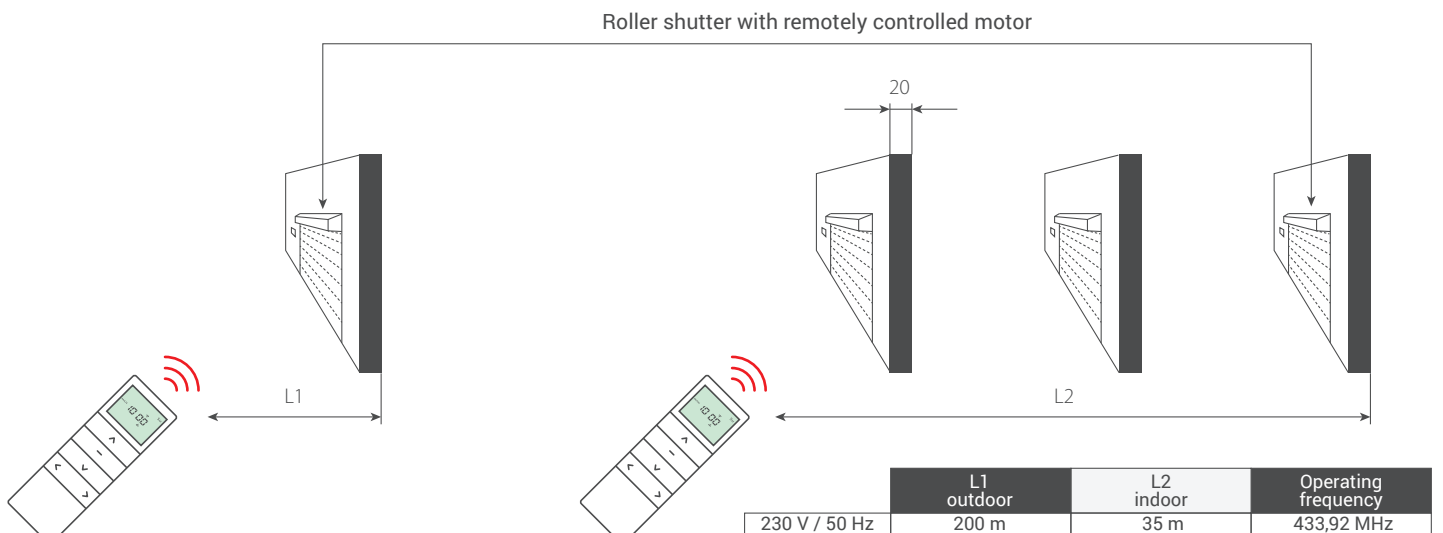



Non-compliance with the specification might cause risk for life or health and can determine proper work of the roller shutter. We strongly recommend to comply with the specification. Installation of the tubular motor should be performed by specialists with 1kV or higher SEP-certified electrician's licence (SEP - Association of Polish Electrical Engineers) or equal license.

Programming first transmitter



Longer than 5 seconds pause between series of button clicks during programming will cause device to switch off from programming mode without saving any changes.

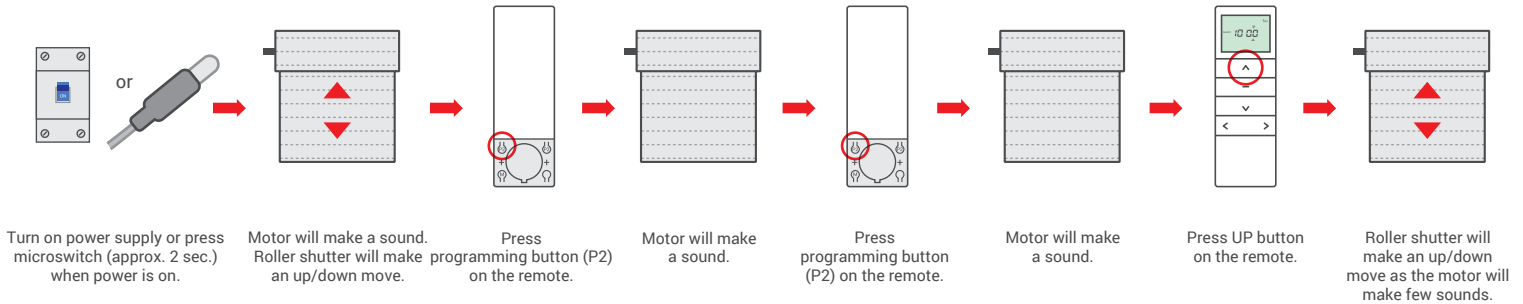

Changing motors direction

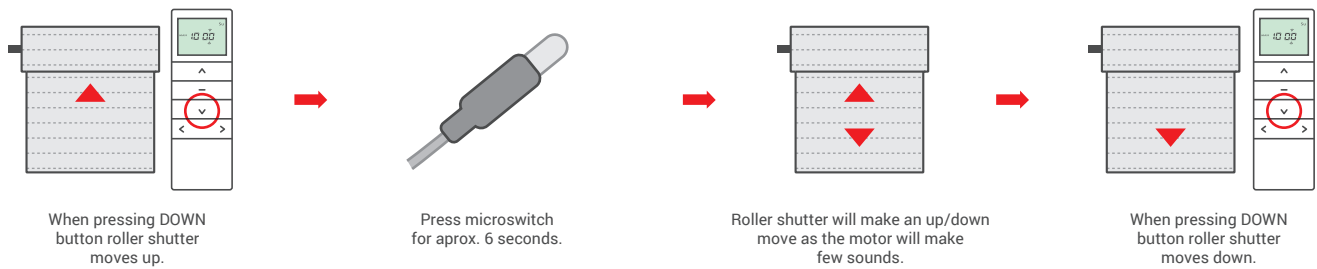

Setting limit positions



Limit positions need to be set manually using supplied regulator.

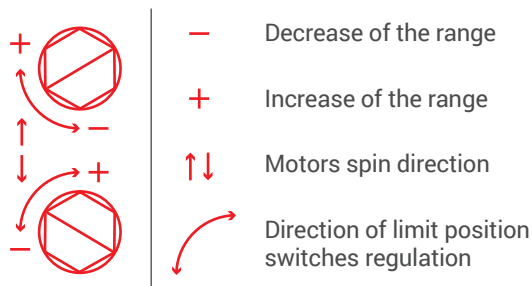

For setting bottom or top limit position roller shutter needs to be started (opening or closing direction) until it stops at the factory set height. For increasing the range of limit position turn the rotary regulator in the '+' direction. Analogically, for decreasing the range, turn in the '-' direction.



Non-compliance with the specification might cause risk for life or health and can determine proper work of the roller shutter. We strongly recommend to comply with the specification. Installation of the tubular motor should be performed by specialists with 1kV or higher SEP-certified electrician's licence (SEP - Association of Polish Electrical Engineers) or equal license.

Programming another transmitter



Receiver can be controlled by up to 20 transmitters. Longer than 5 seconds pause between series of button clicks during programming will cause device to switch off from programming mode without saving any changes.

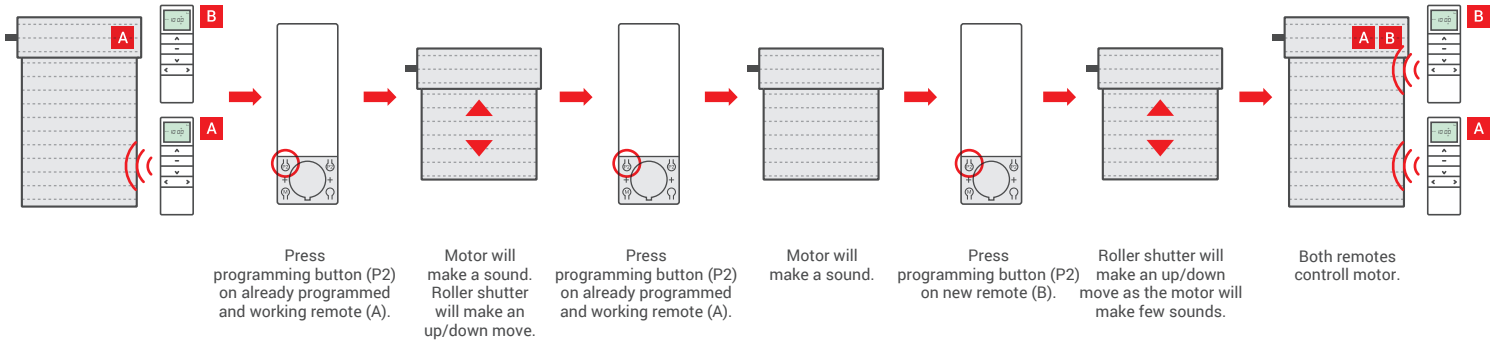

Deleting radio receiver memory



Deleting memory of motors radio receiver will cause for all programmed transmitters to be lost. Longer than 5 seconds pause between series of button clicks during programming will cause device to switch off from programming mode without saving any changes.

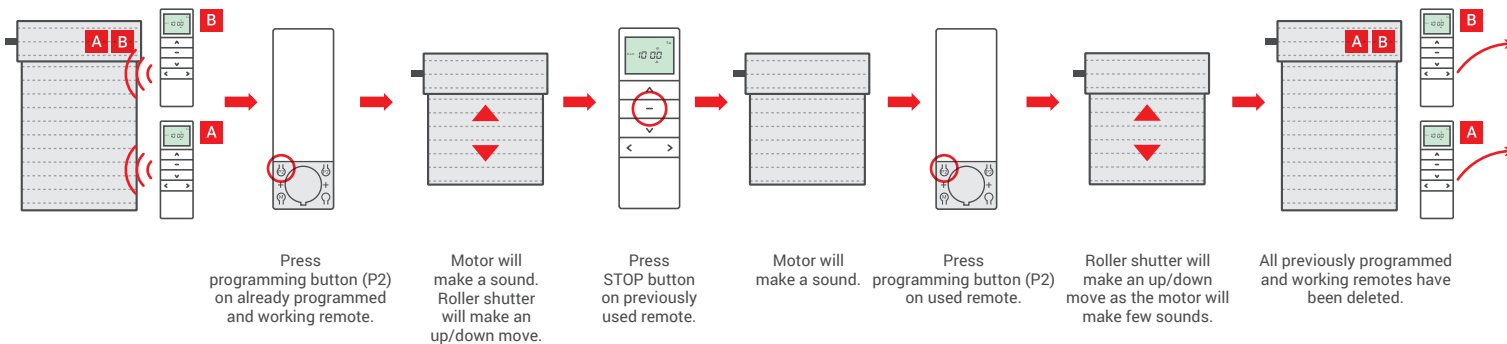

Activating impulse mode



Longer than 5 seconds pause between series of button clicks during programming will cause device to switch off from programming mode without saving any changes. To reverse this procedure please repeat the instruction.

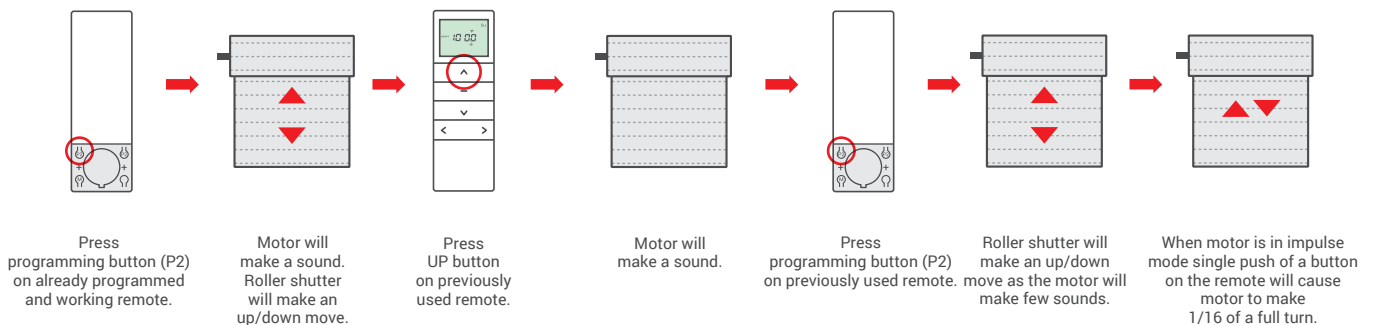

433 MHz



Non-compliance with the specification might cause risk for life or health and can determine proper work of the roller shutter.
We strongly recommend to comply with the specification.
Installation of the tubular motor should be performed by specialists with 1kV or higher SEP-certified electrician's licence
(SEP - Association of Polish Electrical Engineers) or equal license.

Programming key-ring remotes



When programming key-ring remotes that do not have additional P2 programming button the same function is substituted with simultaneous push of STOP and UP buttons.

Longer than 5 seconds pause between series of button clicks during programming will cause device to switch off from programming mode without saving any changes.

